



DOGHER 
 TOOLS
Making Solutions

<p>25 mm 1/4"</p> 	166	<p>30 mm 75 mm 5/16"</p> 	178
<p>50 mm 90 mm 1/4"</p> 	169	<p>30 mm 75 mm 10 mm</p> 	181
<p>110 mm 125 150 mm 200/250 mm 1/4"</p> 	171	 	182
<p>25 mm 1/4" TiN</p> 	174	  	183
<p>30 mm 1/4" Bluefire</p> 	175	 	185
<p>50 mm 75 mm 100/150 mm 1/4"</p> 	176		

Puntas de Atornillar 400

Puntas de Atornillar

Puntas forjadas con una geometría que permite un acople perfecto al tornillo. El cuello central mas blando ofrece una elevada resistencia a la rotura por torsión.

1/4" • 25 mm



25 mm

1/4"

S2

• No se suministra en unidades de embalaje distintas a las indicadas.



400

Punta Phillips



		Part N°	€/		Part N°	€/
PH0	-	-		10	400-PH0-10	12,86
PH1	2	400-PH1-2	2,63	10	400-PH1-10	7,59
PH2	2	400-PH2-2	2,63	10	400-PH2-10	7,59
PH3	2	400-PH3-2	2,63	10	400-PH3-10	7,59
PH4	-	-		10	400-PH4-10	12,86

* Hasta fin de existencias

400

Caja 3 Puntas Phillips



Caja de 3 Puntas PH1 • PH2 • PH3

Part N°	€
400-001	3,28

401

Punta Pozidriv



		Part N°	€/		Part N°	€/
PZ0	-	-		10	401-PZ0-10	12,86
PZ1	2	401-PZ1-2	2,63	10	401-PZ1-10	7,59
PZ2	2	401-PZ2-2	2,63	10	401-PZ2-10	7,59
PZ3	2	401-PZ3-2	2,63	10	401-PZ3-10	7,59
PZ4	-	-		10	401-PZ4-10	12,86

* Hasta fin de existencias

401

Caja 3 Puntas Pozidriv



Caja de 3 Puntas PZ1 • PZ2 • PZ3

Part N°	€
401-001	3,28

1/4" • 25 mm

25 mm 1/4" S2

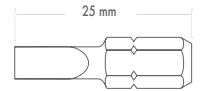

• No se suministra en unidades de embalaje distintas a las indicadas.

400

Expositores de Puntas

10 Cajas de Puntas PH2

Part N°	€
400-001J	75,90

10 Cajas de Puntas PZ2

Part N°	€
400-002J	75,90

10
Pcs



150 x 155 x 200 mm

5 Cajas de Puntas PH2 PZ2

Part N°	€
400-003J	75,90

3 Cajas de Puntas PH2 PZ2

1 Cajas de Puntas PH2x50 PZ2x50

2 Portapuntas Magnéticos 443-050

Part N°	€
400-004J	107,10

402

Punta Recta

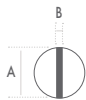

A mm	B mm		Part N°	€/
3	0,5	10	402-030-10	14,20
3,5	0,6	10	402-035-10	14,20
4	0,8	10	402-040-10	14,20
4,5	0,8	10	402-045-10	14,20
5	1	10	402-050-10	14,20
5,5	1	10	402-055-10	14,20
6	1,2	10	402-060-10	14,20
6,5	1,2	10	402-065-10	14,20
8	1,2	10	402-080-10	14,20

404

Punta Torx Seguridad



		Part N°	€/
TS10	10	404-TS10-10	26,93
TS15	10	404-TS15-10	26,93
TS20	10	404-TS20-10	26,93
TS25	10	404-TS25-10	26,93
TS27	10	404-TS27-10	26,93
TS30	10	404-TS30-10	26,93
TS40	10	404-TS40-10	26,93

Puntas de Atornillar



1/4" • 25 mm

25 mm

1/4"

S2

• No se suministra en unidades de embalaje distintas a las indicadas.

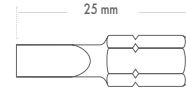

403

Punta Torx



405

Punta Hexagonal



		Part N°	€/		Part N°	€/
T05	-	-	-	-	403-T05-10	18,97
T06	-	-	-	-	403-T06-10	18,97
T07	-	-	-	-	403-T07-10	18,97
T08	-	-	-	-	403-T08-10	18,97
T09	-	-	-	-	403-T09-10	18,97
T10	2	403-T10-2	3,93	10	403-T10-10	14,08
T15	2	403-T15-2	3,93	10	403-T15-10	14,08
T20	2	403-T20-2	3,93	10	403-T20-10	14,08
T25	2	403-T25-2	3,93	10	403-T25-10	14,08
T27	-	-	-	-	403-T27-10	14,08
T30	2	403-T30-2	3,93	10	403-T30-10	14,08
T40	2	403-T40-2	3,93	10	403-T40-10	14,08

		Part N°	€/
HX1,5	10	405-HX015-10	14,45
HX2	10	405-HX020-10	14,45
HX2,5	10	405-HX025-10	14,45
HX3	10	405-HX030-10	14,45
HX4	10	405-HX040-10	14,45
HX5	10	405-HX050-10	14,45
HX6	10	405-HX060-10	14,45
HX8	10	405-HX080-10	17,14
HX10	10	405-HX100-10	21,73

406

Punta Robertson



		Part N°	€/
R1	10	406-R1-10	20,20
R2	10	406-R2-10	20,20
R3	10	406-R3-10	20,20

1/4" • 50 mm

50 mm 1/4" S2

• No se suministra en unidades de embalaje distintas a las indicadas. 

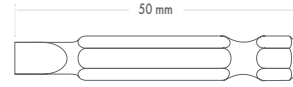

410

Punta Phillips



50 mm



		Part N°	€/ 		Part N°	€/ 
PH1	2	410-PH1-2	6,65	10	410-PH1-10	24,36
PH2	2	410-PH2-2	6,65	10	410-PH2-10	24,36
PH3	2	410-PH3-2	6,65	10	410-PH3-10	24,36
PH4*	-	-	-	-	410-PH4-10	24,36*

* Hasta fin de existencias

411

Punta Pozidriv



50 mm



		Part N°	€/ 		Part N°	€/ 
PZ1	2	411-PZ1-2	6,65	10	411-PZ1-10	24,36
PZ2	2	411-PZ2-2	6,65	10	411-PZ2-10	24,36
PZ3	2	411-PZ3-2	6,65	10	411-PZ3-10	24,36
PZ4*	-	-	-	-	411-PZ4-10	24,36*

* Hasta fin de existencias



412

Punta Recta

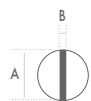

50 mm



A mm	B mm		Part N°	€/ 
3	0,5	10	412-030-10	37,96
3,5	0,6	10	412-035-10	37,96
4	0,8	10	412-040-10	37,96
4,5	0,8	10	412-045-10	37,96
5	1	10	412-050-10	37,96
5,5	1	10	412-055-10	37,96
6	1,2	10	412-060-10	37,96
6,5	1,2	10	412-065-10	37,96
8	1,2	10	412-080-10	37,96





413

Punta Torx



50 mm



		Part N°	€/ 		Part N°	€/ 
T05	-	-	-	-	413-T05-10	39,55
T06	-	-	-	-	413-T06-10	39,55
T07	-	-	-	-	413-T07-10	39,55
T08	-	-	-	-	413-T08-10	39,55
T09	-	-	-	-	413-T09-10	39,55
T10	2	413-T10-2	9,93	10	413-T10-10	40,74
T15	2	413-T15-2	9,93	10	413-T15-10	40,74
T20	2	413-T20-2	9,93	10	413-T20-10	40,74
T25	2	413-T25-2	9,93	10	413-T25-10	40,74
T27	-	-	-	-	413-T27-10	40,74
T30	2	413-T30-2	9,93	10	413-T30-10	40,74
T40	2	413-T40-2	9,93	10	413-T40-10	40,74

Puntas de Atornillar

1/4" • 50 mm

1/4" • 90 mm



50 mm 1/4" S2



• No se suministra en unidades de embalaje distintas a las indicadas.

414

Punta Hexagonal



50 mm



		Part N°	€/
HX2	10	414-HX020-10	46,93
HX2,5	10	414-HX025-10	46,93
HX3	10	414-HX030-10	46,93
HX4	10	414-HX040-10	46,93
HX5	10	414-HX050-10	46,93
HX6	10	414-HX060-10	46,93
HX8	10	414-HX080-10	46,93

415

Punta Robertson



50 mm



		Part N°	€/
R1	10	415-R1-10	31,50
R2	10	415-R2-10	31,50
R3	10	415-R3-10	31,50

416

Punta Phillips



90 mm



		Part N°	€/
PH1	5	416-PH1-5	35,13
PH2	5	416-PH2-5	35,13
PH3	5	416-PH3-5	35,13

417

Punta Pozidriv



90 mm



		Part N°	€/
PZ1	5	417-PZ1-5	35,13
PZ2	5	417-PZ2-5	35,13
PZ3	5	417-PZ3-5	35,13

418

Punta Torx



90 mm



		Part N°	€/
T10	5	418-T10-5	41,85
T15	5	418-T15-5	41,85
T20	5	418-T20-5	41,85
T25	5	418-T25-5	41,85
T30	5	418-T30-5	41,85
T40	5	418-T40-5	41,85

1/4" • 110 mm

110 mm 1/4" S2

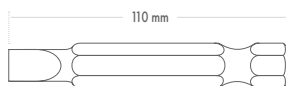

4110

Punta Phillips



110 mm



		Part N°	€/
PH1	1	4110-PH1-1	7,24
PH2	1	4110-PH2-1	7,24
PH3	1	4110-PH3-1	7,24

4110

Punta Pozidriv



110 mm



		Part N°	€/
PZ1	1	4110-PZ1-1	7,24
PZ2	1	4110-PZ2-1	7,24
PZ3	1	4110-PZ3-1	7,24

4110

Punta Torx



110 mm



		Part N°	€/
T10	1	4110-T10-1	8,51
T15	1	4110-T15-1	8,51
T20	1	4110-T20-1	8,51
T25	1	4110-T25-1	8,51
T30	1	4110-T30-1	8,51
T40	1	4110-T40-1	8,51

Puntas de Atornillar

1/4" • 125 mm

1/4" • 150 mm

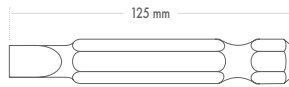

125 mm

1/4"

S2

4125

Punta Phillips



125 mm



		Part N°	€/
PH1	1	4125-PH1-1	7,40
PH2	1	4125-PH2-1	7,40
PH3	1	4125-PH3-1	7,40

4125

Punta Pozidriv



125 mm



		Part N°	€/
PZ1	1	4125-PZ1-1	7,40
PZ2	1	4125-PZ2-1	7,40
PZ3	1	4125-PZ3-1	7,40



150 mm

1/4"

S2

4150

Punta Phillips



150 mm



		Part N°	€/
PH1	1	4150-PH1-1	9,07
PH2	1	4150-PH2-1	9,07
PH3	1	4150-PH3-1	9,07

4150

Punta Pozidriv



150 mm



		Part N°	€/
PZ1	1	4150-PZ1-1	9,07
PZ2	1	4150-PZ2-1	9,07
PZ3	1	4150-PZ3-1	9,07

4150

Punta Torx



150 mm

		Part N°	€/
T10	1	4150-T10-1	10,42
T15	1	4150-T15-1	10,42
T20	1	4150-T20-1	10,42
T25	1	4150-T25-1	10,42
T30	1	4150-T30-1	10,42
T40	1	4150-T40-1	10,42



1/4" • 200 mm

1/4" • 250 mm



4200

Punta Phillips



200 mm



Icon	Quantity	Part N°	Price (€)
	1	4200-PH2-1	12,52

4200

Punta Pozidriv



200 mm



Icon	Quantity	Part N°	Price (€)
	1	4200-PZ2-1	12,52



4250

Punta Phillips



250 mm



Icon	Quantity	Part N°	Price (€)
	1	4250-PH2-1	14,74

4250

Punta Pozidriv



250 mm



Icon	Quantity	Part N°	Price (€)
	1	4250-PZ2-1	14,74

Puntas de Atornillar

Puntas forjadas con recubrimiento TiN (nitruro de titanio), que aporta a la punta una durabilidad hasta 5 veces superior, en especial en trabajos en serie.

TiN

1/4" • 25 mm

25 mm

1/4"

S2

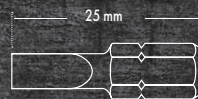

• No se suministra en unidades de embalaje distintas a las indicadas.

TiN

420

Punta Phillips



25 mm



Icon	Part N°	€/Unit	Part N°	€/Unit
	2 420-PH1-2	6,73	5 420-PH1-5	12,37
	2 420-PH2-2	6,73	5 420-PH2-5	12,37
	2 420-PH3-2	6,73	5 420-PH3-5	12,37

TiN

421

Punta Pozidriv



25 mm



Icon	Part N°	€/Unit	Part N°	€/Unit
	2 421-PZ1-2	6,73	5 421-PZ1-5	12,37
	2 421-PZ2-2	6,73	5 421-PZ2-5	12,37
	2 421-PZ3-2	6,73	5 421-PZ3-5	12,37

TiN

422

Punta Recta



25 mm



A mm	B mm	Part N°	€/Unit
4,5	0,8	5 422-045-5	15,39
5,5	1	5 422-055-5	15,39
6,5	1,2	5 422-065-5	15,39

TiN

423

Punta Torx



25 mm



Icon	Part N°	€/Unit	Part N°	€/Unit
	2 423-T10-2	7,93	5 423-T10-5	15,39
	2 423-T15-2	7,93	5 423-T15-5	15,39
	2 423-T20-2	7,93	5 423-T20-5	15,39
	2 423-T25-2	7,93	5 423-T25-5	15,39
	-	-	5 423-T27-5	15,39
	2 423-T30-2	7,93	5 423-T30-5	15,39
	2 423-T40-2	7,93	5 423-T40-5	15,39

Puntas forjadas especialmente diseñadas para trabajos realizados con atornilladores. El cuello central de menor dureza, absorbe los picos causados durante el atornillado evitando la rotura de la cabeza.

La geometría de la punta permite un acople perfecto con el tornillo anulando holguras que pueden causar roturas.

Puntas de Impacto

Bluefire



- Acero de alta tecnología S2
- Máxima resistencia a la torsión
- Alta tenacidad
- Geometría específica, ofrece máxima durabilidad.

30 mm

1/4"

S2

1/4" • 30 mm

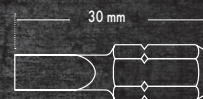

• No se suministra en unidades de embalaje distintas a las indicadas.

427

Punta Phillips



30 mm



Icon	Unit	Part N°	€/Unit	Unit	Part N°	€/Unit
	2	427-PH2-2	11,87	5	427-PH2-5	25,24
	2	427-PH3-2	11,87	5	427-PH3-5	25,24

427

Punta Pozidriv



30 mm



Icon	Unit	Part N°	€/Unit	Unit	Part N°	€/Unit
	2	427-PZ2-2	11,87	5	427-PZ2-5	25,24
	2	427-PZ3-2	11,87	5	427-PZ3-5	25,24

427

Punta Torx



30 mm



Icon	Unit	Part N°	€/Unit	Unit	Part N°	€/Unit
	2	427-T10-2	12,08	5	427-T10-5	25,76
	2	427-T15-2	12,08	5	427-T15-5	25,76
	2	427-T20-2	12,08	5	427-T20-5	25,76
	2	427-T25-2	12,08	5	427-T25-5	25,76
	2	427-T30-2	12,08	5	427-T30-5	25,76
	2	427-T40-2	12,08	5	427-T40-5	25,76

443

Portapuntas de Impacto Magnético con Anillo

60 mm

1/4"

1/4"



L mm	Unit	Part N°	€/Unit
60	1	443-002	19,22

Puntas de Impacto



1/4" • 50 mm

1/4" • 75 mm

Impact series



10X Life



50 mm

1/4"

S2

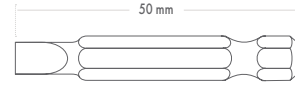

• No se suministra en unidades de embalaje distintas a las indicadas.

425

Punta Phillips



50 mm



		Part N°	€/		Part N°	€/
PH2	2	425-PH2-2	12,89	5	425-PH2-5	27,77
PH3	2	425-PH3-2	12,89	5	425-PH3-5	27,77

425

Punta Pozidriv



50 mm



		Part N°	€/		Part N°	€/
PZ2	2	425-PZ2-2	12,89	5	425-PZ2-5	27,77
PZ3	2	425-PZ3-2	12,89	5	425-PZ3-5	27,77

426

Punta Phillips



75 mm



		Part N°	€/
PH2	5	426-PH2-5	36,65
PH3	5	426-PH3-5	36,65

426

Punta Pozidriv



75 mm



		Part N°	€/
PZ2	5	426-PZ2-5	36,65
PZ3	5	426-PZ3-5	36,65

75 mm

1/4"

S2



1/4" • 100 mm

1/4" • 150 mm

Impact series



10X
Life



100 mm

1/4"

S2

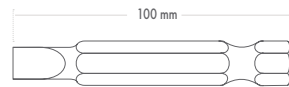

• No se suministra en unidades de embalaje distintas a las indicadas.

428

Punta Phillips



100 mm



		Part N°	€/
PH2	5	428-PH2-5	39,98
PH3	5	428-PH3-5	39,98

428

Punta Pozidriv



100 mm



		Part N°	€/
PZ2	5	428-PZ2-5	39,98
PZ3	5	428-PZ3-5	39,98

429

Punta Phillips



150 mm



		Part N°	€/
PH2	5	429-PH2-5	47,99
PH3	5	429-PH3-5	47,99

429

Punta Pozidriv



150 mm



		Part N°	€/
PZ2	5	429-PZ2-5	47,99
PZ3	5	429-PZ3-5	47,99

Puntas de Atornillar

5/16" • 30 mm

DOGHER
TOOLS



30 mm 5/16" S2

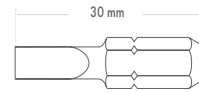

• No se suministra en unidades de embalaje distintas a las indicadas.

430

Punta Phillips



30 mm



		Part N°	€/
PH1	10	430-PH1-10	25,75
PH2	10	430-PH2-10	25,75
PH3	10	430-PH3-10	25,75
PH4	10	430-PH4-10	25,75

431

Punta Pozidriv



30 mm



		Part N°	€/
PZ1	10	431-PZ1-10	25,62
PZ2	10	431-PZ2-10	25,62
PZ3	10	431-PZ3-10	25,62
PZ4	10	431-PZ4-10	25,62

432

Punta Recta



30 mm

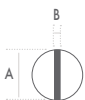

A mm	B mm		Part N°	€/
8	1,2	10	432-080-10	27,10
10	1,6	10	432-100-10	34,87
12	1,8	10	432-120-10	48,82
14	2,3	10	432-140-10	75,73

433

Punta Torx



30 mm



		Part N°	€/
T25	1	433-T25	4,73
T30	1	433-T30	4,73
T40	10	433-T40-10	28,94
T45	10	433-T45-10	28,94
T50	10	433-T50-10	28,94
T55	10	433-T55-10	42,38
T60	10	433-T60-10	76,86

5/16" • 30 mm

5/16" • 75 mm



30 mm

75 mm

5/16"

S2

• No se suministra en unidades de embalaje distintas a las indicadas.

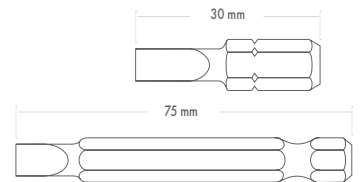

434

Punta Torx Seguridad



30 mm



		Part N°	€/
TS45	10	434-TS45-10	51,81
TS50	10	434-TS50-10	51,81
TS55	10	434-TS55-10	56,55

435

Punta Hexagonal



30 mm



		Part N°	€/
HX4	1	435-HX4	5,78
HX5	1	435-HX5	5,78
HX6	1	435-HX6	5,78
HX8	1	435-HX8	5,78
HX10	10	435-HX10-10	33,13
HX12	10	435-HX12-10	46,38
HX14	10	435-HX14-10	47,70

436

Punta XZN



30 mm



		Part N°	€/
XZN8	5	436-XZN8	32,73
XZN10	5	436-XZN10	32,73

436

Punta XZN



75 mm



		Part N°	€/
XZN8	5	436-XZN8-75	37,95
XZN10	5	436-XZN10-75	37,95

Puntas de Atornillar

10 mm • 30 mm



30 mm

10 mm

S2

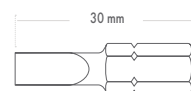

437

Punta Hexagonal



30 mm



		Part N°	€/
HX4	5	437-HX4	14,41
HX5	5	437-HX5	14,41
HX6	5	437-HX6	14,41
HX7	5	437-HX7	14,41
HX8	5	437-HX8	14,41
HX10	5	437-HX10	14,41
HX12	5	437-HX12	15,39

437

Punta Ribe



30 mm



		Part N°	€/
RIBE6	5	437-RIBE6	16,83
RIBE7	5	437-RIBE7	16,83
RIBE8	5	437-RIBE8	16,83
RIBE9	5	437-RIBE9	16,83
RIBE10	5	437-RIBE10	16,83
RIBE12	5	437-RIBE12	22,47
RIBE14	5	437-RIBE14	25,69

437

Punta XZN



30 mm



		Part N°	€/
XZN5	5	437-XZN5	15,15
XZN6	5	437-XZN6	15,15
XZN8	5	437-XZN8	15,15
XZN10	5	437-XZN10	15,15
XZN12	5	437-XZN12	19,56
XZN14	5	437-XZN14	23,13

437

Punta Torx



30 mm



		Part N°	€/
T20	5	437-T20	15,15
T25	5	437-T25	15,15
T30	5	437-T30	15,15
T40	5	437-T40	15,15
T45	5	437-T45	15,15
T50	5	437-T50	15,15
T55	5	437-T55	15,15

437

Punta Robertson



30 mm



		Part N°	€/
R8	5	437-R8	16,05
R10	5	437-R10	17,24

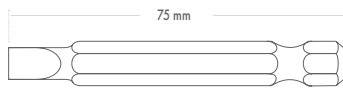

437

Punta Hexagonal



75 mm



		Part N°	€/
HX4	5	437-HX4-75	22,14
HX5	5	437-HX5-75	22,15
HX6	5	437-HX6-75	22,15
HX7	5	437-HX7-75	22,15
HX8	5	437-HX8-75	22,15
HX10	5	437-HX10-75	22,15
HX12	5	437-HX12-75	23,12

10 mm • 115 mm

HX10	1	437-HX10-115	23,69
-------------	---	---------------------	--------------

437

Punta Ribe



75 mm



		Part N°	€/
RIBE6	5	437-RIBE6-75	24,44
RIBE7	5	437-RIBE7-75	24,44
RIBE8	5	437-RIBE8-75	24,44
RIBE9	5	437-RIBE9-75	27,21
RIBE10	5	437-RIBE10-75	27,21
RIBE12	5	437-RIBE12-75	33,17
RIBE14	5	437-RIBE14-75	43,01

437

Punta XZN



75 mm



		Part N°	€/
XZN5	5	437-XZN5-75	18,05
XZN6	5	437-XZN6-75	18,05
XZN8	5	437-XZN8-75	18,05
XZN10	5	437-XZN10-75	23,03
XZN12	5	437-XZN12-75	28,49

437

Punta Torx



75 mm



		Part N°	€/
T20	5	437-T20-75	20,68
T25	5	437-T25-75	20,68
T30	5	437-T30-75	20,68
T40	5	437-T40-75	20,73
T45	5	437-T45-75	20,73
T50	5	437-T50-75	20,73
T55	5	437-T55-75	29,04

10 mm • 115 mm

T55	1	437-T55-115	31,37
------------	---	--------------------	--------------

Puntas de Atornillar



10 mm

Juegos de Puntas de Atornillar

438

Juego de Puntas Hexagonales y Portapuntas

15

Pcs

10 mm

S2



Portapuntas

10 mm ▶ ◀ 1/2" (543-027)

10 mm x 30 mm HX4 • HX5 • HX6 • HX7 • HX8 • HX10 • HX12

10 mm x 75 mm HX4 • HX5 • HX6 • HX7 • HX8 • HX10 • HX12

Part N°

€

438-004

54,24

438

Juego de Puntas Ribe y Portapuntas

15

Pcs

10 mm

S2



Portapuntas

10 mm ▶ ◀ 1/2" (543-027)

10 mm x 30 mm RIBE6 • RIBE7 • RIBE8 • RIBE9
RIBE10 • RIBE12 • RIBE14

10 mm x 75 mm RIBE6 • RIBE7 • RIBE8 • RIBE9
RIBE10 • RIBE12 • RIBE14

Part N°

€

438-005

74,02

438

Juego de Puntas XZN y Portapuntas

11

Pcs

10 mm

S2



Portapuntas

10 mm ▶ ◀ 1/2" (543-027)

10 mm x 30 mm XZN5 • XZN6 • XZN8 • XZN10 • XZN12

10 mm x 75 mm XZN5 • XZN6 • XZN8 • XZN10 • XZN12

Part N°

€

438-006

48,92

438

Juego de Puntas Torx y Portapuntas

15

Pcs

10 mm

S2

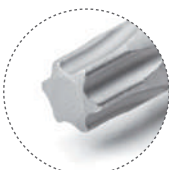

Portapuntas

10 mm ▶ ◀ 1/2" (543-027)

10 mm x 30 mm T20 • T25 • T30 • T40 • T45 • T50 • T55

10 mm x 75 mm T20 • T25 • T30 • T40 • T45 • T50 • T55

Part N°

€

438-007

52,97

440

Vaso Hexagonal Magnético



Ø	Paquete	Part N°	€/Paquete
5	2	440-050	11,97
5,5	2	440-055	11,97
6	2	440-060	11,97
1/4	2	440-1/4	11,97
7	2	440-070	11,97
5/16	2	440-5/16	12,76
8	2	440-080	12,21
3/8	2	440-3/8	12,76
10	2	440-100	12,84
11	2	440-110	13,09
12	2	440-120	13,40
13	2	440-130	13,68

441

Vaso Hexagonal Magnético Largo



Ø	Paquete	Part N°	€/Paquete
6	2	441-060	13,17
7	2	441-070	13,17
8	2	441-080	13,44
10	2	441-100	14,12
11	2	441-110	14,39
12	2	441-120	14,74
13	2	441-130	15,36

440

Kit de Vasos Magnéticos

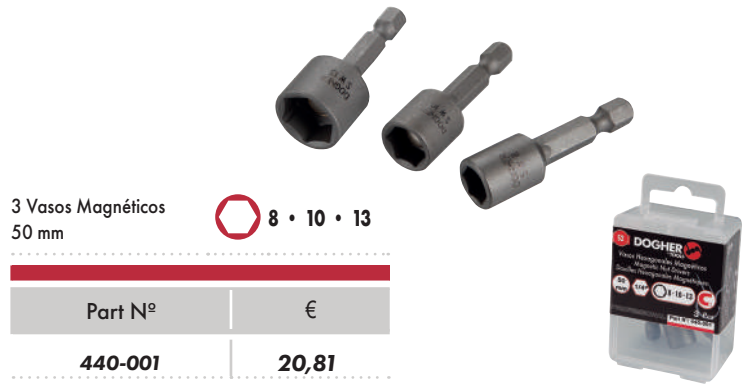

3 Vasos Magnéticos
50 mm

8 • 10 • 13

Part N°	€
440-001	20,81

7 Vasos Magnéticos
50 mm

6 • 7 • 8 • 10
13 • 5/16 • 3/8

Part N°	€
440-005	50,76

3 Vasos Magnéticos 50 mm
4 Vasos Magnéticos 65 mm

8 • 5/16 • 3/8
6 • 7 • 10 • 13

Part N°	€
440-006	51,96

3 Vasos Magnéticos
65 mm

8 • 10 • 13

Part N°	€
441-001	22,90

7 Vasos Magnéticos
65 mm

6 • 7 • 8 • 10
11 • 12 • 13

Part N°	€
441-005	55,86

Puntas de Atornillar



443

Portapuntas Magnético con Anillo

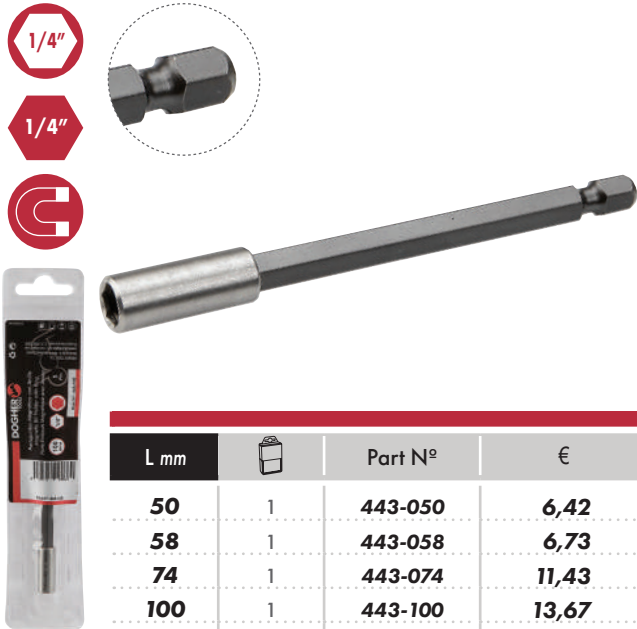

L mm		Part N°	€
50	1	443-050	6,42
58	1	443-058	6,73
74	1	443-074	11,43
100	1	443-100	13,67
200	1	443-200	17,11

445

Portapuntas Magnético SDS Plus con Anillo



L mm		Part N°	€
78	1	445-001	15,76

440

Kit de Vasos Magnéticos y Portapuntas



5 Vasos Magnéticos 50 mm
2 Portapuntas 50-74 mm

6 • 7 • 8
10 • 13

Part N°	€
440-007	56,74

5 Vasos Magnéticos
2 Portapuntas 50-58 mm

8 • 10 • 13
8 • 10
50 mm
65 mm

Part N°	€
440-008	53,85

444

Adaptador flexible

1/4"
1/4"
300 mm

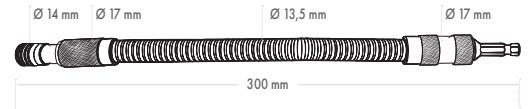

Part N°	€
444-001	32,53

443

Atornillador angular para puntas de 1/4"

1/4"
1/4"



- Válido para puntas de atornillar y brocas con mango hexagonal.
- Diseñado para trabajar en espacios reducidos.
- Se recomienda usar exclusivamente en taladros atornilladores de batería.

Part N°	€
443-001	32,31

Juegos de Puntas de Atornillar

438

Juego de Puntas y Portapuntas

32 Pcs
1/4"
25 mm



✦ T06 • T07 • T08 • T09 • T10 • T15 • T20 • T25 • T27 • T30 • T40 ● HX3 • HX4 • HX5 • HX6
 ● 3 • 4 • 5 • 6 • 7 ✦ PZ0 • PZ1 • PZ2 • PZ3 ✦ PH0 • PH1 • PH2 (x3) • PH3

Adaptador

1/4" ◀ ▶ 1/4" (509-030)

Portapuntas Magnético con Anillo • 60 mm

1/4" ◯ ▶ 1/4"

Part N°	€
438-001	41,94

338

Juego de Puntas y Llave de Carraca

32 Pcs
1/4"
25 mm



✦ T06 • T07 • T08 • T09 • T10 • T15 • T20 • T25 • T30 • T40 ● HX3 • HX4 • HX5 • HX6
 ● 3 • 4 • 5 • 6 • 7 ✦ PZ0 • PZ1 • PZ2 • PZ3 ✦ PH0 • PH1 • PH2 • PH3

■ R0 • R1 • R2 • R3

Llave de Carraca



Part N°	€
438-002	44,60

Puntas de Atornillar

Juegos de Puntas de Atornillar



438

Juego de Puntas y Llave de Carraca

11

Pcs

1/4"

25 mm



PH1 · PH2 · PH3

PZ1 · PZ2 · PZ3

3 · 4 · 5 · 6

Llave de Carraca



Part N°

€

438-003

39,69



10

Pcs

230 x 210 x 155 mm

Part N°

€

438-003J

396,90

438

Juego de Puntas y Llave de Carraca

58

Pcs

1/4"

25 mm



3 · 4 · 4,5 · 5 · 6 · 7 · 8

PZ0 · PZ1 · PZ2 · PZ3

1 · 2 · 3

PH0 · PH1 · PH2 · PH3

TW1 · TW2 · TW3 · TW4

HX1,5

HXS2,0 · HXS2,5 · HXS3,0 · HXS4,0 · HXS5,0 · HXS6,0

R0 · R1 · R2 · R3

TQ06 · TQ08 · TQ10

T5 · T6

TS7 · TS8 · TS9 · TS10 · TS15 · TS20 · TS25 · TS30 · TS40

XZN4 · XZN5 · XZN6 · XZN8

4 · 6 · 8 · 10

Portapuntas Magnético con Anillo · 60 mm / Atornillador Ref. 343-007

Adaptador 1/4" ◀ ▶ 1/4" (509-030)

Part N°

€

438-008

71,19



7

Pcs

275 x 290 x 140 mm

Part N°

€

438-008J

498,33